



clear glass

SOLUTIONS

T H E C H O I C E I S C L E A R

Product NRG Hydraulic Glass Hinge

Material # Stainless Steel

Finish Polished

Model:CAH-WG

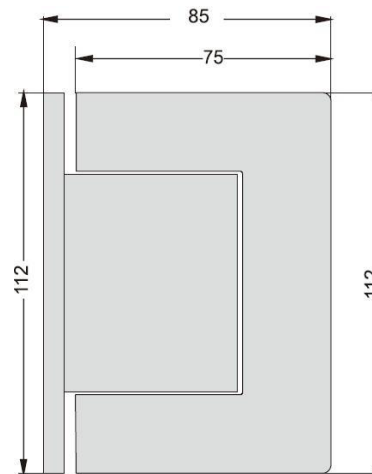
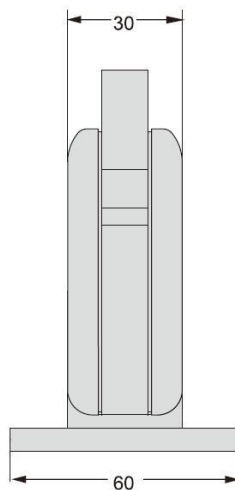

Features

- Glass To Wall/ Glass to post Model
- Both hold-open and non hold-open available
- Non Hold open hinges ideal for pool fencing.
- Suitable for 10-14mm toughened or laminated glass
- Self- centering when door is closed.
- Simple Valve adjustment for closing speed control.
- Closing speed can be faster or slower with a quick simple adjustment
- Double action closing speed. Hinges close more quickly until 15 degrees and then slow for a soft close.
- Maximum door leaf width: 900mm
- Maximum door leaf weight: 70kg
- Glass to glass fixing 90 degrees
- Solid Stainless steel construction
- Tested to 500,000 cycles
- Currently available mirror polish. Satin finish available Dec 2011

Clear Glass Solutions PTY LTD Australia www.clearglass.com.au

TEL: 03 5942 8444 Fax 03 5942 9286 email info@clearglass.com.au



NRGI GLASS HINGES

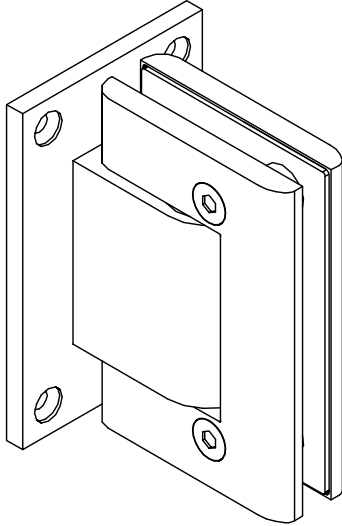

Note:

Each Pair of NRGI glass hinges consists of one damping hinge and one closing hinge. The damping hinge adjusts the closing speed. To ensure the best performance, the closing hinge should always be installed below the damping hinge

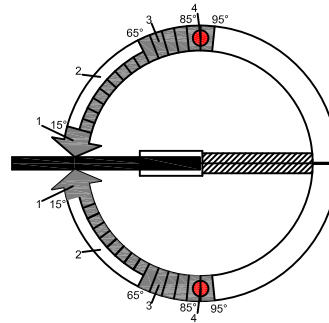

1. Closing range: 15°-0°
2. Closing speed adjustable range: 65°-15°
3. Closing speed non-adjustable range: 85°-65°
4. Hold-open: 90° (optional)

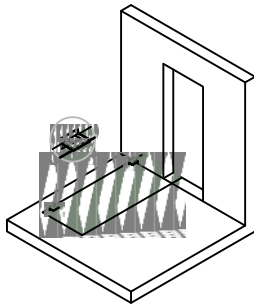

Step 1:
Fix the hinge onto the glass door.

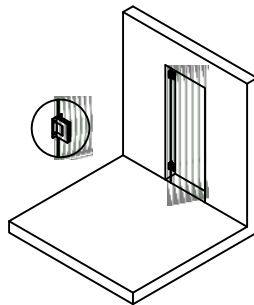

Step 2:
Fix the hinge mounted glass door onto masonry or sidepanel.

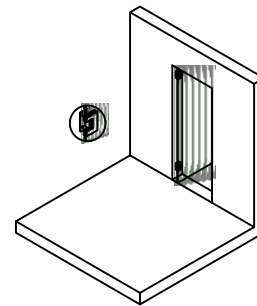

Step 3:
Open the door and adjust the closing speed by adjustable valve.

Precaution: Be careful not to loosen off the adjustment screw too far as this will render the hinge inoperable. Warranties will also be void if screw is loosened too far.

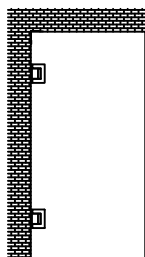

Wall to Glass Fixing
Single Leaf Operation

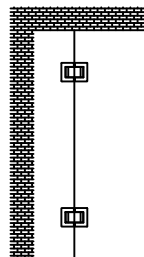

Glass to Glass Fixing
Single Leaf Operation

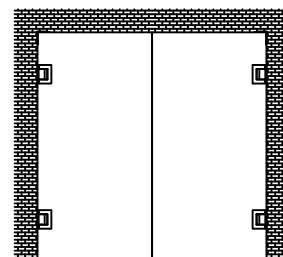

Wall to Glass Fixing
Double Leaf Operation

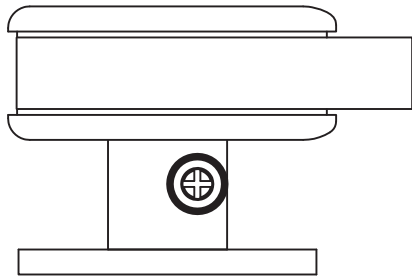

Fast+ ← → - Slow

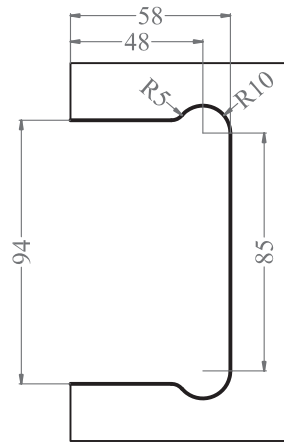

CAH-WG

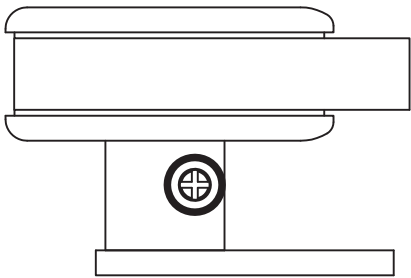

Fast+ ← → - Slow

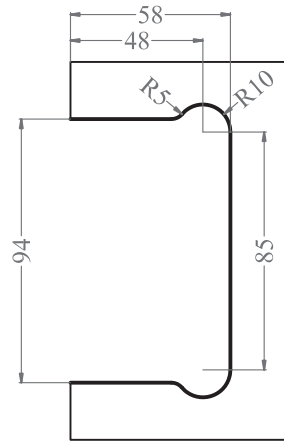

CAH-WG

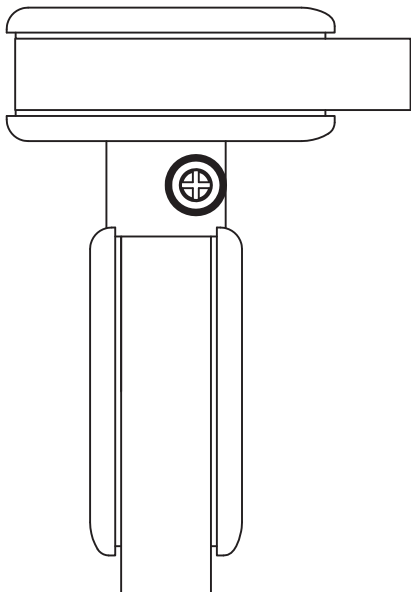

Fast+ ← → - Slow

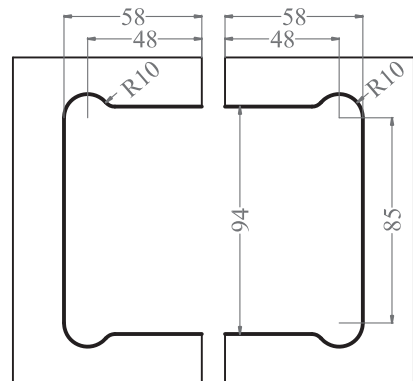

CAH-GG